

Catálogo '08

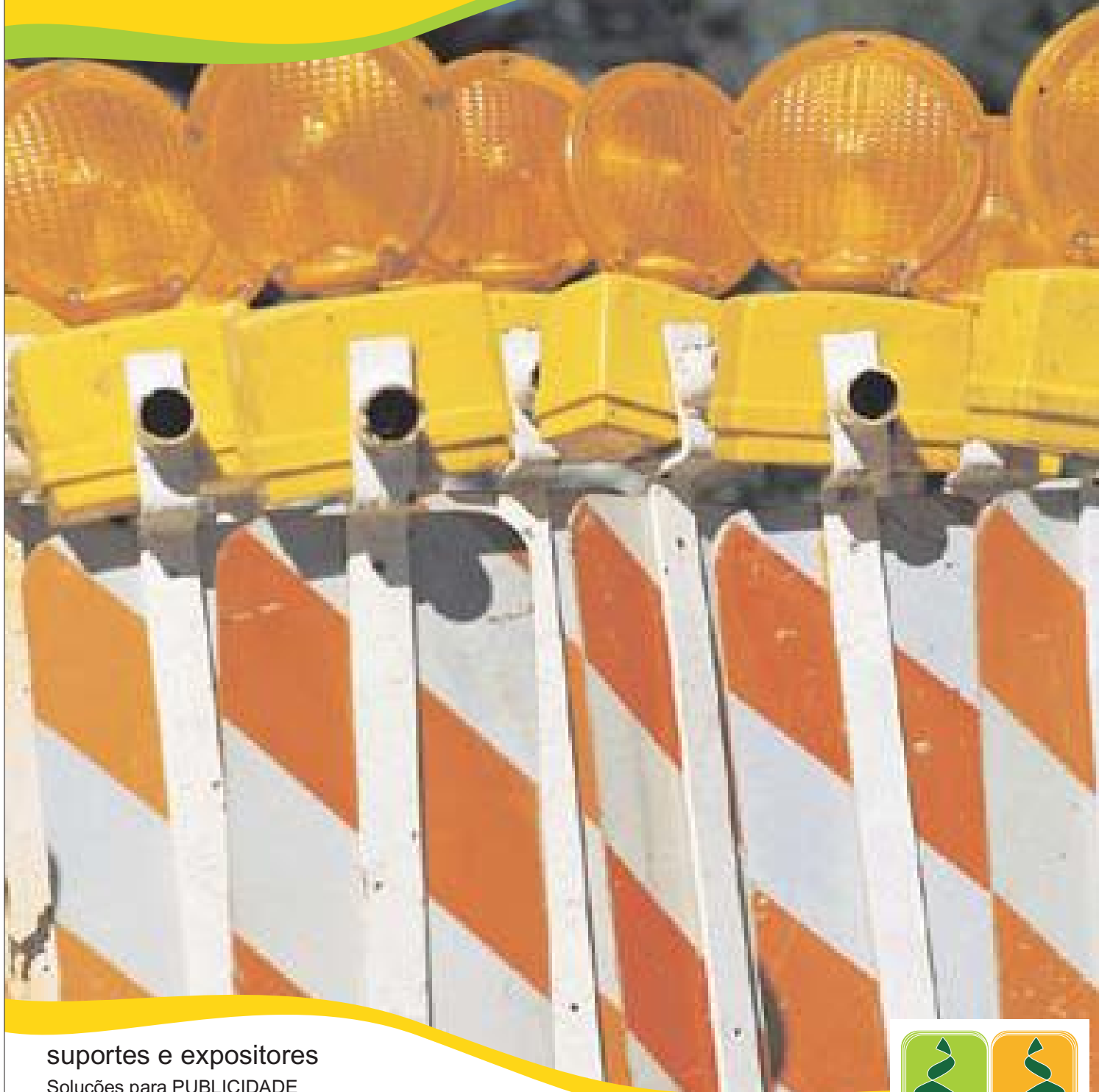

suportes e expositores
Soluções para PUBLICIDADE



www.printstudio.com.pt

ateliersueste@gmail.com

atelierSueste

Rua D. João V - Centro Comercial Miravila,
Loja 16 (1º andar) Tel:(+351) 289 316 354
8125-256 Quarteira
Portugal

◀ Sistemas de Exposição

EXTAND



Sistemas de exposição para apresentação em feiras ou exposições, fácil de montar e transportar, de grande impacto visual. sistemas tipo POP-UP versáteis em **ESTRUTURAS 3 X 3** ou **3 X 4** CURVO ou DIREITO

inclui:

BARRAS MAGNÉTICAS; MALA BALCÃO* e/ou TRANSPORTE;
FOCOS HALOGÉNICO;
PAINÉIS PVC 700 MICRONS com aplicação de imagem impressa em alta definição (qualidade fotográfica), acabamento c/ laminação (plastificado) de alto brilho ou mate.

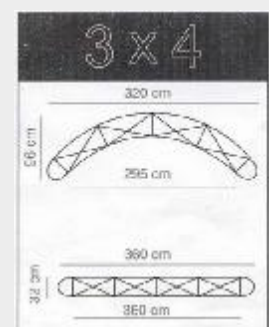
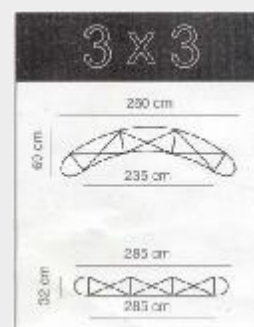

◀ Sistemas de Exposição

ACESSÓRIOS

HANGER KICKER LATERAL/FRONTAL DIREITO
[ref.º EXTAND1000HKFD]

HANGER KICKER LATERAL/FRONTAL CURVO INTERIOR
[ref.º EXTAND1000HKFIC]

HANGER KICKER FRONTAL CURVO EXTERIOR
[ref.º EXTAND1000HKFEC]



FOCO HALOGENICO
[ref.º EXTAND1100FOCOH]

PAINÉIS DE PVC
[ref.º EXTAND1000PVCE]

BARRA METÁLICA
[ref.º EXTAND1000BMAG]



NÓ SEGURADOR
[ref.º EXTAND1000NO]



ROLO MAGNÉTICO
[ref.º EXTANDMAG]



TOPO DE MADEIRA P/MALA BALCÃO
[ref.º EXTAND1100TOPOMAD]



EXTAND 1000

(inclui barras magnéticas e reforços superior, painéis em pvc e projectores e mala de transporte/bancada)

- a) **ESTRUTURA 3 X 3 CURVO** [ref.º EXTAND10003X3C]
- b) **ESTRUTURA 3 X 3 DIREITO** [ref.º EXTAND10003X3D]
- c) **ESTRUTURA 3 X 4 CURVO** [ref.º EXTAND10003X4C]
- d) **ESTRUTURA 3 X 4 DIREITO** [ref.º EXTAND10003X4D]

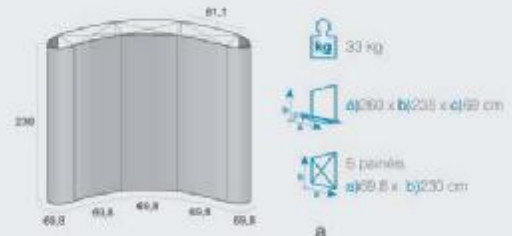

◀ Sistemas de Exposição

ACESSÓRIOS



BIG MAGNET
[ref.º EXTAND1100BIGMAG]

2 unid.



BARRA MAGNÉTICA
[ref.º EXTAND1100BMAG]

unid.



FOCO HALOGÉNIO
[ref.º EXTAND1100FOCOH]

unid.



**TOPO DE MADEIRA
P/MALA BALÇÃO**
[ref.º EXTAND1100TOPOMAD]

unid.



EXTAND 1100

(inclui barras magnéticas e reforços superior,
painéis em pvc e projectores e mala de transporte/bancada)

- a) **ESTRUTURA 3 X 3 CURVO** [ref.º EXTAND11003X3C]
- b) **ESTRUTURA 3 X 3 DIREITO** [ref.º EXTAND11003X3D]
- c) **ESTRUTURA 3 X 4 CURVO** [ref.º EXTAND11003X4C]
- d) **ESTRUTURA 3 X 4 DIREITO** [ref.º EXTAND11003X4D]



**HANGER KICKER
FRONTAL DIREITO** unid.
[ref.º EXTAND1100HKFD]

**HANGER KICKER FRONTAL
CURVO EXTERIOR** unid.
[ref.º EXTAND1100HKFEC]

**HANGER KICKER FRONTAL
CURVO INTERIOR** unid.
[ref.º EXTAND1100HKFIC]



HANGER KICKER LATERAL unid.
[ref.º EXTAND1100HKL]



ROLO MAGNÉTICO unid.
[ref.º EXTANDMAG]

PAINÉIS DE PVC unid.
[ref.º EXTAND1000PVCCE]

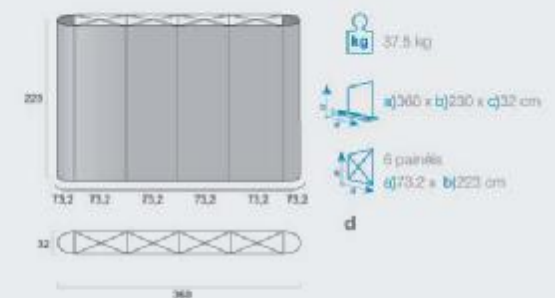
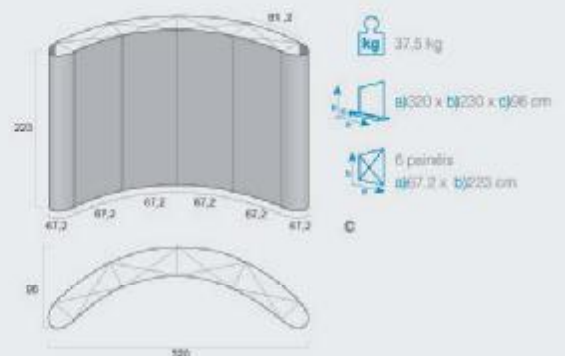
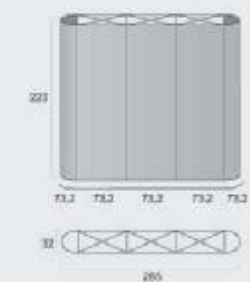
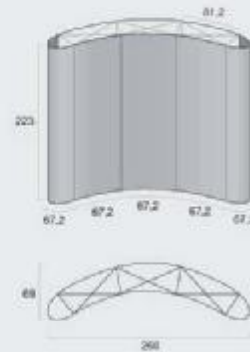

◀ Sistemas de Exposição

ACESSÓRIOS

HANGER KICKER LATERAL/FRONTAL DIREITO unid.
[ref.º EXTAND1000HKFD]

HANGER KICKER LATERAL/FRONTAL CURVO INTERIOR unid.
[ref.º EXTAND1000HKFIC]

HANGER KICKER FRONTAL CURVO EXTERIOR unid.
[ref.º EXTAND1000HKFEC]



FOCO HALOGENICO unid.
[ref.º EXTAND1100FOCCH]

BARRA METÁLICA unid.
[ref.º EXTAND1000BMAG]



NÓ SEGURADOR unid.
[ref.º EXTAND1000NO]



ROLO MAGNÉTICO unid.
[ref.º EXTANDMAG]

PAINÉIS DE PVC unid.
[ref.º EXTAND1000PVCDE]

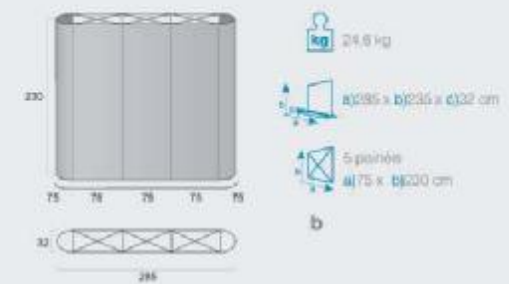
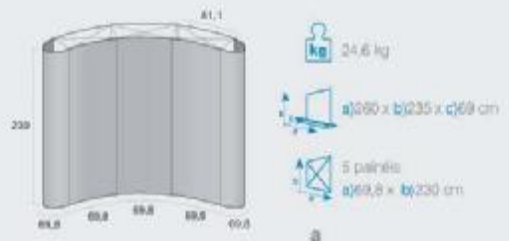

EXTAND ECONÔMICO

(inclui barras magnéticas e reforços superior, painéis em pvc e projectores e mala de transporte)

- a) ESTRUTURA 3 X 3 CURVO [ref.º EXTANDECO3X3C]
- b) ESTRUTURA 3 X 3 DIREITO [ref.º EXTANDECO3X3D]
- c) ESTRUTURA 3 X 4 CURVO [ref.º EXTANDECO3X4C]
- d) ESTRUTURA 3 X 4 DIREITO [ref.º EXTANDECO3X4D]

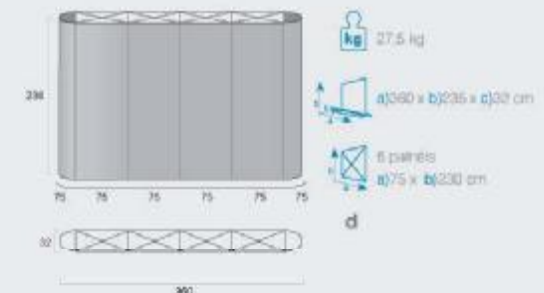
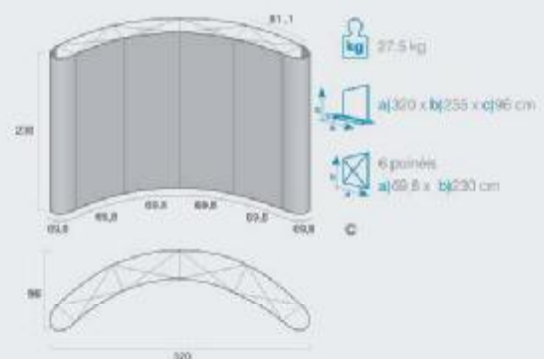

◀ Sistemas de Exposição

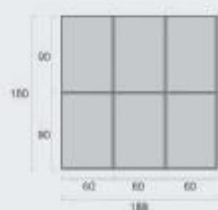

13,5 kg



a) 160 x b) 190 x c) 50 cm



5 painéis a) 60 x b) 90 cm

FOLDING PANEL 2x3

[ref.º FPANEL2X3]

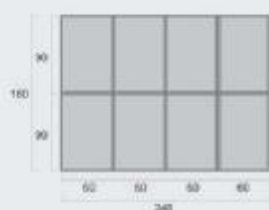

18 kg



a) 230 x b) 190 x c) 50 cm



5 painéis a) 60 x b) 90 cm

FOLDING PANEL 2x4

[ref.º FPANEL2X4]



◀ Sistemas de Exposição



19,1 kg a)85 x b)126 x c)65 cm N/A

TORRE CIRCULAR C/ 4 NÍVEIS
Estrutura elegante e de fácil montagem.
[ref.º EPT4N]



19,5 kg a)138 x b)91 x c)55 cm a)250 x b)88 cm
Não inclui painéis de PVC

EXTEND BALCÃO
[ref.º EXTANDBALCAO2X2C]



11,5 kg a)86 x b)226 x c)64 cm a)202 x b)82 + a)78 x b)30 cm

BANCADA PROMOTORA EXPOOSURE
[ref.º EXPOBANCADA]



4,4 kg a)65 x b)178 x c)44 cm (sob consulta)
Não inclui painéis de PVC

BANCADA PROMOTORA ECONÓMICA 1
[ref.º EXPOBANCADAECO1]



5,6 kg a)82 x b)181 x c)45 cm a)181 x b)75 + a)78 x b)30

BANCADA PROMOTORA ECONÓMICA 2
[ref.º EXPOBANCADAECO2]

◀ Sistemas de Exposição

ROLL SCREEN S5
85 x 200 cm
sistema de exposição
estático elegante
de montagem rápida

2,2 kg a)90 x b)205 x c)40 cm a)83,5 x b)195 cm

ROLL SCREEN S8
85 x 200 cm
sistema de exposição
estático elegante
de montagem rápida

4,4 kg a)89 x b)205 x c)22 cm a)84 x b)195 cm

TOP IMAGE
[ref.º TOPIMA21000880]

4 kg a)90 x b)215 cm a)88 x b)210 cm

KIT DE LUZ
1 face
[ref.º TOPIMAKITLUZ] unid.

ROLL SCREEN DOBLE SIDE
85 x 200 cm
sistema de exposição
estático elegante
de montagem rápida

5,2 kg a)87 x b)210 x c)89 cm a)85 x b)200 cm

ROLL SCREEN DOUBLE SIDE
"Roll up" com duas faces.
[ref.º RSDS085200]

◀ Sistemas de Exposição



ROLL SCREEN S7
"Roll up" com uma face.
[ref.º RSS7085200]

1,9 kg a) 186 x b) 205 x c) 40 cm a) 84 x b) 198 cm

ROLL SCREEN S7
"Roll up" com uma face.
[ref.º RSS7100200]

2,2 kg a) 171 x b) 205 x c) 40 cm a) 88 x b) 198 cm

ROLL SCREEN S7
"Roll up" com uma face.
[ref.º RSS8120200]

2,9 kg a) 121 x b) 205 x c) 40 cm a) 118 x b) 198 cm



ROLL SCREEN CLASSIC
"Roll up" com uma face.
a) Roll Screen Classic [ref.º RSC085216];
b) Roll Screen Classic Black [ref.º RSCB085216]

4,5 kg a) 86 x b) 218 x c) 24 cm a) 86 x b) 216 cm

◀ Sistemas de Exposição



8,6 kg



a)97 x b)199 x c)30 cm



a)85 x b)195 cm (x2)

AUTO SCREEN ASRS7

"Roll up" com duas faces.

[ref.º ASRS7085200]



5 kg



a)90 x b)203 x c)25 cm



a)77 x b)199 cm (x2)

AUTO SCREEN ASRS8

"Roll up" com duas faces.

[ref.º ASRS8060200]

◀ Sistemas de Exposição



0.9 kg a)95 x b)105 x c)8 cm: a)50 x b)100 cm (x2)

AUTO SCREEN ASRS6

"Roll up" com duas faces.

[ref.º ASRS60500]

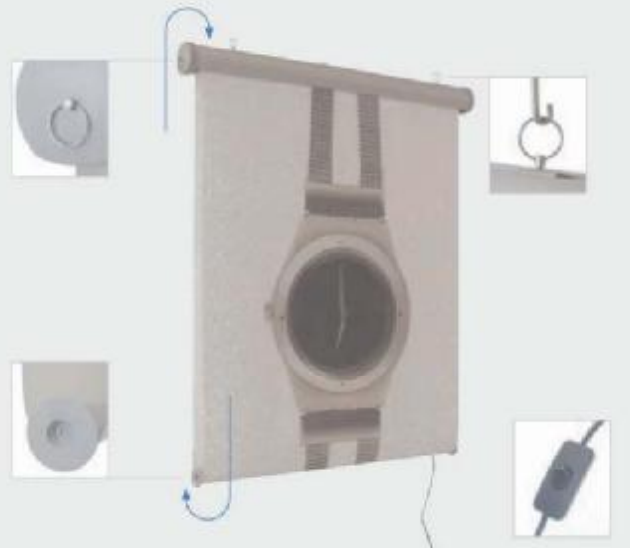

2.5 kg a)90 x b)110 x c)10 cm: a)85 x b)100 cm (x2)

AUTO SCREEN RS

[ref.º ASRS085]



AUTO SCREEN ASRS5

"Roll up" de parede com duas faces.

[ref.º ASRS50800]



2.5 kg a)90 x b)105 x c)8 cm: a)80 x b)100 cm (x2)

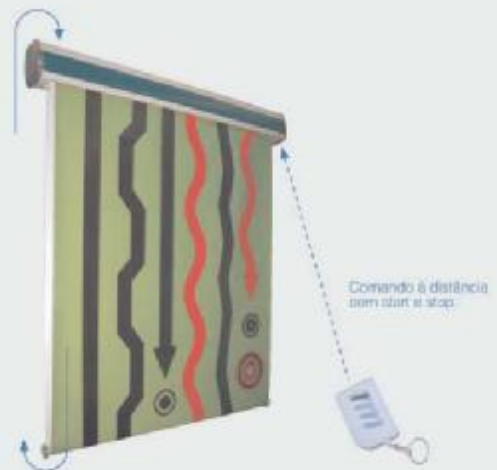

AUTO SCREEN ASRS4

"Roll up" de parede com duas faces.

[ref.º ASRS40800]

◀ Sistemas de Exposição



1 - TOP TEM
Ajustável em altura
[ref.º TOPTEM23000880]



EXPOSITOR EASY BANNER
[ref.º EB06502000]



EXPOSITOR EASY BANNER
[ref.º EB09002000]



KIT DE LUZ unid.

1 face
[ref.º TOPTEMK/ILUZ1F]

2 faces
[ref.º TOPTEMK/ILUZ2F]



EXPOSITOR EASY BANNER
[ref.º EB09002200]



EXPOSITOR EASY BANNER
[ref.º EB06502200]



EXPOSITOR EASY BANNER
[ref.º EBECO06001800]

◀ Sistemas de Exposição



EXPOSITOR "X BANNERS"

[ref.º XBANNER-50600-1650]



EXPOSITOR "X BANNERS5"

[ref.º XBANNER-50800-1800]

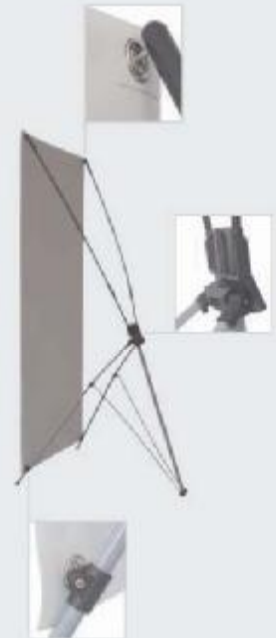

EXPOSITOR "X" EXPOSURE

[ref.º XEXPO1200-2500]



EXPOSITOR "X" EXPOSURE

[ref.º XEXPO0900-2000]



EXPOSITOR "X" EXPOSURE

[ref.º XEXPO0800-1800]

◀ Sistemas de Exposição



L - LUX BANNER
[ref.º LLDANINET10902-16]



L - LUX BANNER
[ref.º LLBANNER060200]



EXPO SPRINT
[ref.º EXPOSPRINT0800]
BARRA DUPLA FACE
[ref.º EXPOSPRINTB0800]



EXPO SPRINT
[ref.º EXPOSPRINT0300]

BARRA DUPLA FACE
[ref.º EXPOSPRINTB0600]



EXPO SPRINT
[ref.º EXPOSPRINT01000]

BARRA DUPLA FACE
[ref.º EXPOSPRINTB01000]

◀ Sistemas de Exposição



EXPOSITOR TRIPLE SCREEN
Estrutura elegante de tripla face
[ref.ª TS0900-2200]



EXPOSITOR "X BANNER 1"
[ref.ª XBANNER-10250-0450]



EXPOSITOR "X BANNER 2"
[ref.ª XBANNER-20600-1600]



EXPOSITOR "X BANNER 3"
[ref.ª XBANNER-30600-1600]



EXPOSITOR "X BANNER 4"
[ref.ª XBANNER-40800-1800]

◀ Sistemas de Exposição



RACK EXPO 5
Estrutura autoportante de montagem rápida.
[ref.º RACKEXPO5]



RACK EXPO 6
Estrutura autoportante de montagem rápida.
[ref.º RACKEXPO6]



PF 2500 A3
Moldura reposicionável c/ pé
[ref.º PF2500A3RPE]



RACK EXPO 4
Estrutura autoportante de montagem rápida.
[ref.º RACKEXPO4]



PF2500 A4R
Estrutura autoportante de montagem rápida.
4)[ref.º PF2500A4R]



PF2500 A2R
Estrutura autoportante de montagem rápida.
2)[ref.º PF2500A2R]



PF2500 A3R
Estrutura autoportante de montagem rápida.
3)[ref.º PF2500A3R]



PF2500 B2R
Estrutura autoportante de montagem rápida.
1)[ref.º PF2500B2R]



PF 2500 A4
Moldura reposicionável c/ pé
[ref.º PF2500A4RPE]

◀ Sistemas de Exposição



RACK EXPO 1
Estrutura autoportante de montagem rápida.
[ref.º RACKEXPO1]



RACK EXPO 2
Estrutura autoportante de montagem rápida.
[ref.º RACKEXPO2]



EXPOSITOR PORTÁTIL A4
[ref.º EpA4]



EXPOSITOR NYLON A4 SIMPLES
[ref.º ENA4SIMPLES]



EXPOSITOR NYLON A4 DUPLO
[ref.º ENA4]

◀ Sistemas de Exposição



6,2 kg



a)70 x b)112 x c)40 cm



(x2) a)60 x b)90 cm

MUPI WATER DOUBLE

[ref.º MUPWD060090]



6,1 kg



a)70 x b)112 x c)40 cm



a)60 x b)90 cm

MUPI WATER SIMPLE

[ref.º MUPWS060090]



35 kg



a)83 x b)138 x c)55 cm



(x2) a)56 x b)93 cm

MUPI WATER DOUBLE LIGHT

[ref.º MUPIWDL085120]



2,9 kg



a)62 x b)189 x c)40 cm



a)60 x b)157 cm

MUPI WATER SIMPLE

[ref.º MUPIWS060160]



13,1 kg



a)86 x b)275 x c)56 cm



(x2) a)81,5 x b)236 cm

MUPI WATER DOUBLE

[ref.º MUPWD085250]

◀ Sistemas de Exposição



EXPOSITOR LIGHT BOX TOWER ROTATIVO
[ref.ª LBTOWERR]



EXPOSITOR LIGHT BOX TOWER
[ref.ª LBTOWER]



MUPI WATER DOUBLE LIGHT
[ref.ª MUPIWDL08512G]



EXPOSITOR LIGHT BOX SKY
[ref.ª LBSKY]



EXPOSITOR LIGHT BOX GREEN
[ref.ª LBGREEN]



EXPOSITOR LIGHT BOX FRAME
[ref.ª LBFFRAME]

◀ Sistemas de Exposição



MUPI FLEX
Base em lacado branco
[ref.º MUPI700X1000]

17 kg a)70 x b)100 x c)100 cm d)70 x b)100 cm

MUPI FLEX
Base em lacado branco
[ref.º MUPI545X1000]

16 kg a)55 x b)130 x c)100 cm d)55 x b)100 cm



CAVALETE A0
Estrutura elegante e de fácil montagem.
[ref.º CAVALETE-A0]

14,7 kg a)80 x b)155 x c)88 cm d)83,5 x b)117,5 cm



CAVALETE A1
Estrutura elegante e de fácil montagem.
[ref.º CAVALETE-A1]

8,8 kg a)64 x b)115 x c)64 cm d)60 x b)60 cm

◀ Sistemas de Exposição



4,6 kg a)75 x b)200 x c)75 cm (x2) a)80 x b)161 cm

OUTDOOR BANNER WATER DOUBLE Y
[ref.º OBWDY160060]

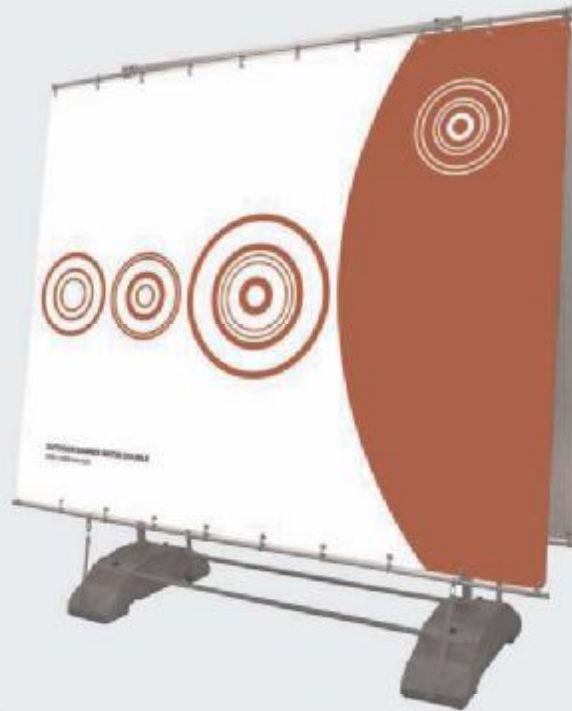

18,5 kg a)252 x b)252 x c)80 cm (x2) a)250 x b)290 cm

OUTDOOR BANNER WATER DOUBLE
[ref.º OBWD250200]



4,2 kg a)75 x b)200 x c)75 cm a)60 x b)161 cm

OUTDOOR BANNER WATER SINGLE Y
[ref.º OBWSY160060]

◀ Sistemas de Exposição

The image displays four different outdoor flag display systems. Each system is shown with a photograph of the flag on its stand, a weight icon, a diagram of the stand's dimensions, and a diagram of the flag's dimensions. The systems are arranged in two rows. The top row features 'OUTDOOR FLAG WATER 2' and 'OUTDOOR FLAG WATER 3'. The bottom row features 'OUTDOOR FLAG WATER 4', 'OUTDOOR FLAG AUTO 2', and 'OUTDOOR FLAG AUTO 1'.

System	Weight (kg)	Stand Dimensions (cm)	Flag Dimensions (cm)
OUTDOOR FLAG WATER 2 [ref.º OFWATER2350100]	16,1	a)150 x b)535 x c)80 cm e)100 x b)400 cm	a)150 x b)535 x c)80 cm
OUTDOOR FLAG WATER 3 [ref.º OFWATER3400100/50]	16,6	a)150 x b)535 x c)80 cm (x3) a)50 x b)100 x c)400 cm	a)150 x b)535 x c)80 cm
OUTDOOR FLAG WATER 4 [ref.º OFWATER4]	16,1	a)80 x b)725 x c)80 cm a)150 x b)130 cm	a)80 x b)725 x c)80 cm
OUTDOOR FLAG AUTO 2 [ref.º OFALTO2]	1,9	a)47 x b)220 x c)25 cm a)35 x b)25 cm	a)47 x b)220 x c)25 cm
OUTDOOR FLAG AUTO 1 [ref.º OFALTO1]	7,2	a)85 x b)580 x c)27 cm a)80 x b) máx. 500 cm	a)85 x b)580 x c)27 cm

◀ Sistemas de Exposição

»SISTEMA KLEMETRIC CONSTRUÇÃO DE STANDS

KLEM-MINI ^a

LIGADOR KLEM-MINI [ref.º ASS021]

INSERIDOR DE ESPESSURA

4mm [ref.º ASS022]

6mm [ref.º ASS023]

8mm [ref.º ASS024]

LIGAÇÃO PARA TUBO

Ø 13mm [ref.º ASS031]

PÉ [ref.º ASS032]



KLEM-SUPER ^b

LIGADOR KLEM-SUPER [ref.º ASS029]

INSERIDOR DE ESPESSURA

10mm [ref.º ASS025]

12mm [ref.º ASS026]

16mm [ref.º ASS027]

19mm [ref.º ASS028]

LIGAÇÃO PARA TUBO

Ø 20mm [ref.º ASS059]

PÉ [ref.º ASS032]

